

Fair stand

Your main presence: System Stand

System Stand (Standard)

Our ready-made system stands are available in various sizes from 4 sqm and include walls, carpet (grey rep), book shelves, bench cabinets, electrical connection (1 kW) in the ceiling frame and stand sign(s). The stand price also includes – depending on stand size – a fixed number of exhibitor passes (incl. free ticket for public transport).

Smaller companies and start-ups can benefit from a reduced stand rental fee when ordering a 4/6/8 sqm stand – exhibitor diversity is important for us.

For further equipment of your system stand we offer you different furniture packages as well as other elements and extras.

Row stand 4 sqm	€ 1,260.–
Row stand 6 sqm	€ 2,663.–
Row stand 8 sqm	€ 3,550.–
Row stand 12 sqm	€ 6,240.–
For each additional 4 sqm	€ 2,080.–



Basic 4 sqm System Stand



8 sqm System Stand with Elements & Extras



Here you can find all the necessary technical information on our System Stand.
Based on a floor grid of 2x2 metres, you can choose any stand size.

The price of the System Stand includes:

- / Floor carpet (grey rep)
- / Side and back walls according to the width and breadth of your stand
- / Four bookshelves per 1m wall panel
- / One bench cabinet per 1m back wall panel
- / One ceiling frame per 4 sqm, incl. conductor rail and one connection (1 kW) to the mains
- / Support walls for stands > 8 sqm (according to structural needs)
- / Stand signs with company name and location (2 signs for stands > 8 sqm)
- / Exhibitor passes (quantity according to stand size)

Additional extras that you can book at registration:

- / Furniture & Light Packages
- / Elements & Extras
- / Or you request an offer for a System Stand Deluxe (≥12 sqm)

Information:

The standard carpet colour in the main aisles is anthracite ("anthracite").
The main vertical and circumferential aisles will have red carpet ("tomato").



System Stand examples

Depending on the size and type of stand, certain structural elements may be required to support the ceiling frames and ensure overall stability. Such elements may include individual supporting walls, full or half-open 1m wall panels, as well as corner constructions made of a mix of those. The book shelves are not included in the perspective representations.

System Stand 4 sqm

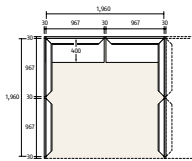

Dimensions (D × W):

2 m × 2 m

Surface area:

4 sqm

Interior dimensions:

1.96 m × 1.96 m

Prices*:

€ 1,398.– (standard price)

€ 1,362.– (early-bird price)

System Stand 6 sqm

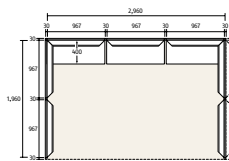

Dimensions (D × W):

2 m × 3 m

Surface area:

6 sqm

Interior dimensions:

1.96 m × 2.96 m

Prices*:

€ 2,801.– (standard price)

€ 2,736.– (early-bird price)

System Stand 8 sqm

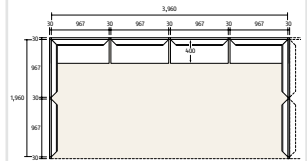

Dimensions (D × W):

2 m × 4 m

Surface area:

8 sqm

Interior dimensions:

1.96 m × 3.96 m

Prices*:

€ 3,944.– (standard price)

€ 3,858.– (early-bird price)



System Stand 12 sqm

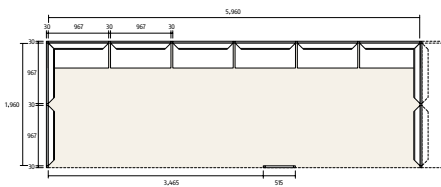

Dimensions (D × W): 2 m × 6 m
Surface area: 12 sqm
Interior dimensions: 1.96 m × 5.96 m
Prices*: € 6,634.– (standard price)
€ 6,448.– (early-bird price)

System Stand 24 sqm

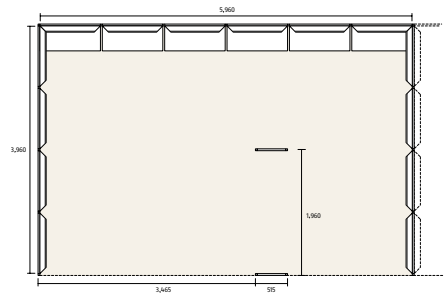

Dimensions (D × W): 4 m × 6 m
Surface area: 24 sqm
Interior dimensions: 3.96 m × 5.96 m
Prices*: € 13,019.– (standard price)
€ 12,647.– (early-bird price)

* The sample prices include the fee for the space, the System Stand material, the obligatory environment and energy surcharge, and the obligatory marketing fee for the main exhibitor. Fees for co-exhibitors are invoiced separately and are not included in these prices. Prices do not include VAT.



Detailed measurements for System Stands

A dimensional tolerance of +/- 10 mm must be taken into account.

Wall element

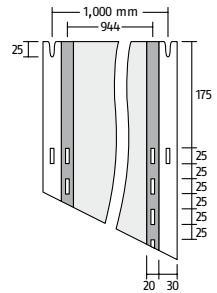
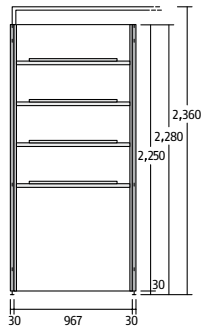
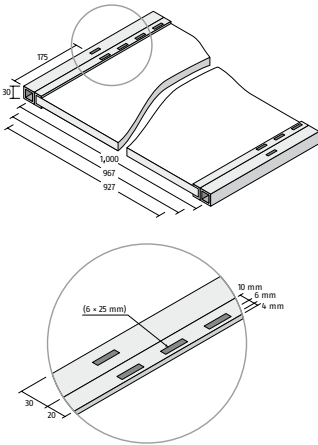

Dimensions (D x H x W):

24 mm x 2,250 mm x 927 mm

Maximum load for a stand-alone wall: 55 kg

Maximum load for connected walls: 65 kg

Ceiling frames

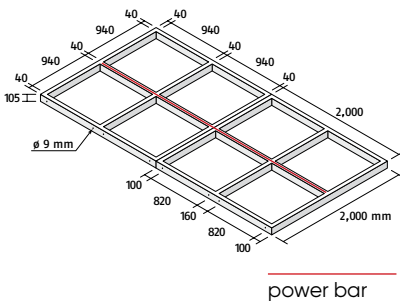

power bar

Two adjacent ceiling frames (2 m x 2 m) with power bar above them in the middle.

Ceiling frames (6 sqm)

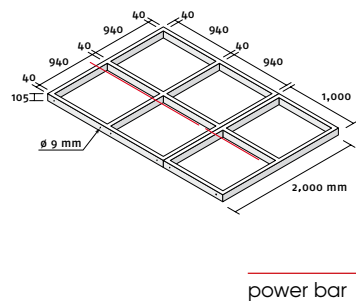

power bar

Two adjacent ceiling frames (2 m x 2 m & 1 m x 2 m) with a conductor rail running through the middle.



Bookshelf

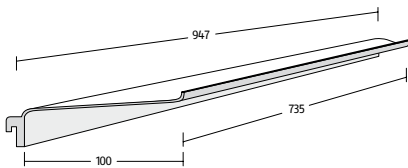

Maximum load: 10 kg per shelf.

Bench cabinet

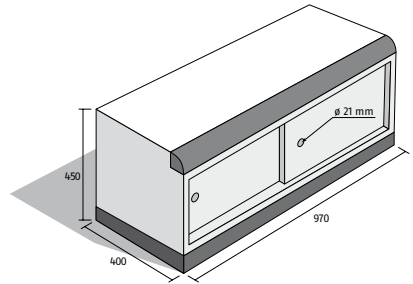

Locks can be purchased at the fair. Bench cabinets must not be stacked on top of each other. Maximum load: 100 kg per bench cabinet.

Support wall with two brochure holders

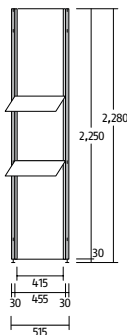

Dimensions (D x H x W):

24 mm x 2,250 mm x 415 mm

Each support wall can support max. 2 brochure holders. Maximum load: 3 kg per brochure holder. Support walls that border back or side walls do not have brochure holders.

Stand nameplate

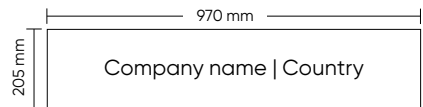

Electric socket

The electric socket is connected directly into the conductor rail within the ceiling frame. Additional electric sockets can be ordered from our partner electrician. All other works such as the laying of cables or additional kilowatts must be ordered from and paid to this service contractor.

For contact information, please see: buchmesse.de/service-contractors



System Stand Deluxe

System Stand Deluxe	Price according to quotation
---------------------	------------------------------

System Stand Smart

4 sqm System Stand Smart	€ 3,825.–
8 sqm System Stand Smart	€ 6,314.–

Space for custom-built stands

8 sqm row stand	€/sqm 402.–
>8 sqm row stand	€/sqm 471.–

Fees for special stand positions

Corner stand or walk-through row stand (fronting 2 aisles)	+ 10% of space rental fee
Peninsula stand (fronting 3 aisles, only for stands > 16 sqm)	+ 15% of space rental fee
Island stand (fronting 4 aisles, only for custom-built stands > 100 sqm)	+ 20% of space rental fee

These surcharges for special stand positions will only be charged for the first 75 square metres. We will try to take your wishes into consideration, but unfortunately cannot guarantee special placement. Please note that the side walls of our system stands cannot be completely removed – this includes corner stands. In order to enable a more flexible stand design in corner positions, we will exchange the side wall with a half-open wall free of charge, if this has been requested in the registration form.

Co-exhibitor fee

In order to ensure that your subsidiary companies or imprints get the reach they need, it is important to list them as co-exhibitors. The participation fee per co-exhibitor includes the environment surcharge and marketing fee. Each co-exhibitor receives his own entry in the online Exhibitor Catalogue, an individual stand sign, an exhibitor pass and by registering at My Book Fair full access to our online services.

Price per co-exhibitor	€ 328.–
------------------------	---------



Mandatory fees

Please note that the mandatory environment and energy surcharge and the marketing fee apply for all registrations.

Your registration thereby contributes to the environmental friendliness of Frankfurter Buchmesse. The environment and energy surcharge (variable according to stand size) covers eco-friendly waste disposal, your electrical supply (1 kW) and usage at the stand (green electricity), hall air conditioning and eco-friendly basic cleaning. .

Environment and energy surcharge

4 sqm stand	€ 29.–
8–12 sqm stand	€ 95.–
> 12 sqm stand	€ 240.–

Marketing fee

Frankfurter Buchmesse offers a comprehensive range of marketing and communication services to increase the quality of encounters at the fair and its relevance for specific specialist circles.

As an exhibitor, you can easily book these services to help advertise your company, products and authors. Here are a few examples:

- / The Calendar of Events, where you can list your events to benefit from its wide reach for free
- / Improved matchmaking opportunities make it easier to look for and find exciting contacts through the app and on-site
- / Themed areas that improve the visibility and accessibility of specialist topics throughout the halls
- / BOOKFEST, which brings your stories directly to the readers even beyond the fair
- / Encounters around the world during the entire year at international events in Europe, Asia, and North and South America
- / Offers for unexpected and new participants in the fair from related digital business areas

Marketing fee	€ 299.–*
---------------	----------

* A € 190 discount is applied to stands of 8 sqm or less.



Better communication with Tellit

Tellit (tellitapp.com) is a social media and content management tool that offers support for monitoring social media activities and the publication of social media posts. The tool can be used to search channels, such as Instagram, Twitter and Facebook, for certain key words or hashtags and thereby analyse what is being said about your own company. In addition, picture galleries and slideshows can be created using your own photos and social media posts. Social walls can also be published on your own site.



As part of the marketing fee, you can use Tellit for free for one year. Please send an e-mail with your customer number to hello@tellitapp.com. Tellit was developed as part of the EU project EMMA (2017-2018) in cooperation with Frankfurter Buchmesse.

Fair preparation from A to Z:

For five days, your stand at Frankfurter Buchmesse becomes your company headquarters. It's where the course is set for the coming year. We provide you online with the most important information to ensure that everything goes well – whether it's planning, setting up your stand or getting the most out of your time at the fair:

buchmesse.de/fair-preparation